

- PL Instrukcja montażu
 D Montageanleitung
 NL Handleiding voor de montage
 TR Montaj talimatı
 F Notice de montage
 CZ Montážní návod
 HU Szerelési útmutató
 GB Assembly instructions
 RU Инструкция по монтажу
 IT Istruzioni di montaggio
 SK Návod na montáž
 RO Instrucțiuni de montaj
 ES Instrucciones de montaje

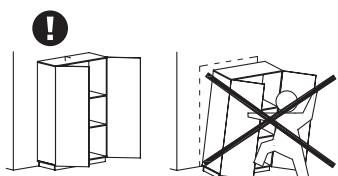

2024-06-13

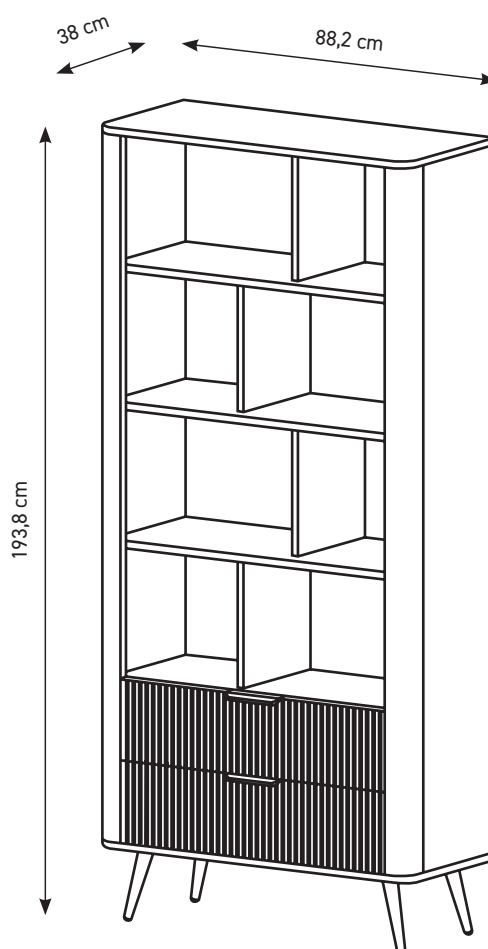

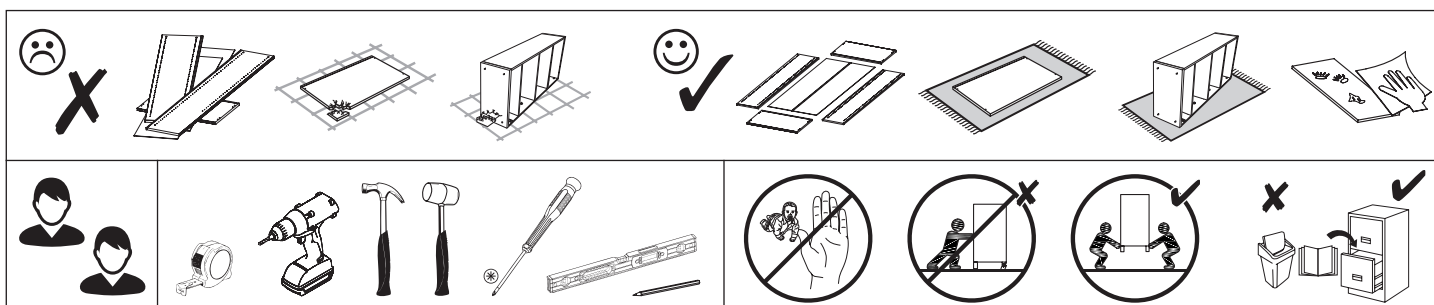

PL Przed rozpoczęciem montażu mebla wszystkie elementy należy sprawdzić czy nie są uszkodzone. W przypadku wykrycia uszkodzenia elementu należy odstąpić od montażu mebla i złożyć reklamację. Montaż produktu w oparciu o uszkodzone elementy oznacza akceptację ich stanu przez Kupującego, co powoduje, że reklamacja uszkodzonych elementów nie będzie uznawana.

Nie wolno przekraczać podanych maksymalnych wartości obciążenia. W innym przypadku można mebel uszkodzić lub zniszczyć.

Przed zawieszeniem mebla, lub przymocowaniem go do ściany (w celu zabezpieczenia przed przewróceniem), sprawdź wcześniej rodzaj i wytrzymałość ściany. Dobierz odpowiednie kotki i wkręty do rodzaju ściany. W przypadku wątpliwości skontaktuj się ze specjalistą. Montaż musi zostać wykonany przez osobę kompetentną.

D Vor Beginn der Möbelmontage sollten alle Elemente auf Beschädigungen überprüft werden. Wenn ein Element des Produkts beschädigt ist, installieren Sie das Produkt bitte nicht und reichen Sie eine Beschwerde ein. Die Installation des Produkts auf der Grundlage der beschädigten Elemente bedeutet, dass der Käufer seinen Zustand akzeptiert, was bedeutet, dass die Beschwerde über beschädigte Elemente nicht akzeptiert wird.

Überschreiten Sie die angegebenen Maximalbelastungen nicht. Andernfalls kann das Möbelstück beschädigt oder zerstört werden.

Bevor Sie ein Möbelstück an einer Wand aufhängen oder befestigen (um es gegen Umkippen zu sichern), prüfen Sie Art und Tragfähigkeit der Wand. Wählen Sie für die Wand geeigneten Dübel und Schrauben. Im Zweifelsfall kontaktieren Sie bitte einen Fachmann. Die Montage muss durch eine sachkundige Person ausgeführt werden.

F Avant de commencer l'assemblage du meuble, tous les éléments doivent être vérifiés pour détecter tout dommage. Si un élément du produit est endommagé, veuillez ne pas installer le produit et déposer une plainte. L'installation du produit sur la base des éléments endommagés signifie que l'Acheteur accepte leur état, ce qui signifie que la réclamation d'éléments endommagés ne sera pas acceptée.

Ne dépassez pas les charges maximum indiquées. Sinon, le meuble peut être endommagé ou détruit.

Avant de suspendre le meuble ou de le fixer au mur (dans le but d'éviter un renversement), vérifiez au préalable le type et la résistance du mur. Utilisez les chevilles et les vis adaptées au type de mur. En cas de doute, veuillez contacter un spécialiste. Le montage doit être réalisé par une personne compétente.

CZ Před zahájením montáže nábytku je třeba zkontrolovat poškození všech prvků. Pokud je některý prvek produktu poškozen, zdržte se instalace produktu a podejte stížnost. Instalace výrobku na základě poškozených prvků znamená, že kupující akceptuje jejich stav, což znamená, že reklamacie poškozených prvků nebude uznána.

Nepřekračujte uvedené maximální zatížení. V opačném případě může dojít k poškození nebo zničení nábytku.

Před zavěšením nábytku nebo jeho připevněním ke zdi (za účelem zajištění před převrácením) dříve zkontrolujte druh a odolnost stěny. Vyberte k druhu stěny vhodné hmoždinky a šrouby. V případě pochybností kontaktujte specialistu. Montáž musí být provedena kompetentní osobou.

HU A bútor szerelés megkezdése előtt ellenőrizni kell az összes elem sérülését. Ha a termék bármely eleme megsérült, kérjük, tartózkodjon a termék telepítésétől és nyújtson be panaszt. A termék sérült elemek alapján történő felszerelés azt jelenti, hogy a Vevő elfogadja azok állapotát, ami azt jelenti, hogy a sérült elemek igényét nem fogadják el. A megadott maximális terhelési értékeket nem szabad túllépni. Ellenkező esetben a bútor megsérülhet vagy megsemmisülhet.

A bútor felfüggesztése illetve falhoz való rögzítése (megakadályozván ezzel eldőléseinek lehetőségét) előtt ellenőrizze a fal fajtáját és szilárdságát. Megfelelő, a falhoz illő tiptiket és csavarokat használjon. Ha kétsége támadna, konzultáljon szakemberrel. A felszerelést csakis egy hozzáértő szakember végezheti el.

GB Before starting the furniture assembly, all elements should be checked for damage. If any element of the product is damaged, please refrain from installing the product and file a complaint. Installation of the product on the basis of the damaged elements means the Buyer's acceptance of their condition, which means that the complaint of damaged elements will not be accepted.

The specified maximum load values must not be exceeded. Otherwise, the piece of furniture may be damaged or destroyed.

Before suspending or fixing furniture to the wall (in order to prevent falling over), check the type and strength of the wall. Select wall plugs and screws appropriate for the given type of the wall. In the case of doubts, contact a specialist. The installation must be performed by a competent person.

SK Pred začatím montáže nábytku by sa mali skontrolovať všetky prvky, či nie sú poškodené. Ak je niektorý prvok výrobku poškodený, neinštalujte výrobok a reklamujte ho. Inštalácia produktu na základe poškodených prvkov znamená, že Kupujúci akceptuje ich stav, čo znamená, že reklamácia poškodených prvkov nebude akceptovaná.

Uvedené hodnoty maximálneho zaťaženia nesmú byť prekročené. V opačnom prípade môže dôjsť k poškodeniu alebo zničeniu nábytku. Pred zaviesním nábytku alebo jeho pripewnením na stenu (za účelom zaistenia pred prevrátením) predtým skontrolujte druh a odolnosť steny. Vyberte k druhu steny vhodné hmoždinky a skrutky. V prípade pochybností kontaktujte špecialistu. Montáž musí byť vykonaná kompetentnou osobou.

RU Перед началом сборки мебели следует проверить все элементы на предмет повреждений. Если какой-либо элемент продукта поврежден, пожалуйста, воздержитесь от установки продукта и подайте жалобу. Установка товара на поврежденные элементы означает, что Покупатель принимает их состояние, а значит, претензии по поврежденным элементам не принимаются.

Указанные максимальные значения нагрузки не должны превышаться. В противном случае предмет мебели может быть поврежден или уничтожен.

Перед подвешиванием мебели или ее креплением к стене (для защиты от падений) проверьте предварительно тип и прочность стены. Подберите соответствующие типу стены дюбели и шурупы. При возникновении сомнений свяжитесь со специалистом. Монтаж должен проводиться компетентным лицом.

IT Prima di iniziare l'assemblaggio del mobile, tutti gli elementi dovrebbero essere controllati per danni. Se qualche elemento del prodotto è danneggiato, astenersi dall'installare il prodotto e presentare un reclamo. L'installazione del prodotto sulla base degli elementi danneggiati implica l'accettazione da parte dell'Acquirente della loro condizione, il che significa che il reclamo per elementi danneggiati non sarà accettato.

I valori di carico massimo specificati non devono essere superati. In caso contrario, il mobile potrebbe essere danneggiato o distrutto.

Prima di appendere i mobili, oppure attaccarli al muro (per proteggerli da ribaltamenti), verifica prima la tipologia e resistenza del muro. Scegli i tasselli e viti più adatti per il tipo di muro. In caso di dubbi contattare uno specialista. Il montaggio deve essere fatto da una persona competente.

NL Voordat u met de meubelmontage begint, moeten alle elementen op schade worden gecontroleerd. Als een onderdeel van het product beschadigd is, installeer het dan niet en dien een klacht in. Installatie van het product op basis van de beschadigde elementen betekent dat de koper hun staat accepteert, wat betekent dat de claim voor beschadigde elementen niet wordt geaccepteerd.

Overschrijd de aangegeven maximale belastingen niet. Anders kan het meubelstuk worden beschadigd of vernield.

Voordat u het meubel ophangt of bevestigt tegen de muur (om het te beschermen tegen omvallen) dient u het type en de duurzaamheid van deze muur na te kijken. Maak gebruik van pluggen en schroeven die geschikt zijn voor het type muur. Neem in geval van twijfel contact op met een specialist. De assemblage dient te worden uitgevoerd door iemand met kennis van zaken.

TR Mobilya montajına başlamadan önce tüm elemanlarda hasar olup olmadığını kontrol edilmelidir. Ürünün herhangi bir parçası hasar görmüşse, lütfen ürünü kurmayın ve şikayete bulunun. Ürünün hasarlı elemanlar bazında montajı, Alıcının durumunu kabul ettiği anlamına gelir, bu da hasarlı elemanlar için talep kabul edilmeceği anlamına gelir.

Belirtilen azami yük değerini aşmayın, aksi takdirde mobilya parçaları zarar görebilir veya kullanılamaz hale gelebilir.

Mobilyayı duvara asmadan veya montaj etmeden önce (devrilmesini önlemek için) duvarın türünü ve dayanıklılığını kontrol edin. Duvara uygun dübelleri ve vidaları seçin. Emin olamadığınız durumda bir uzman ile iletişime geçin. Kurulum yetkili bir kişi tarafından yapılmalıdır.

RO Înainte de a începe asamblarea mobilierului, toate elementele trebuie verificate pentru a nu se deteriora. Dacă vreun element al produsului este deteriorat, vă rugăm să vă abțineți de la instalarea produsului și să depuneți o reclamație. Instalarea produsului pe baza elementelor deteriorate înseamnă acceptarea de către Cumpărător a stării lor, ceea ce înseamnă că reclamația privind elementele deteriorate nu va fi acceptată.

Valoriile maxime de sarcină specificate nu trebuie depășite. În caz contrar, piesa de mobilier poate fi deteriorată sau distrusă.

Înainte de suspendarea unei piese de mobilier sau atașarea acestuia la perete (pentru a preveni bascularea), verificați în prealabil tipul și gradul de rezistență a peretelui. Montați diblurile și șuruburile adecvate pentru tipul de perete. În caz de îndoieli, consultați un specialist. Instalarea trebuie să fie efectuată de către o persoană competentă.

ES Antes de comenzar el montaje de los muebles, todos los elementos deben comprobarse en busca de daños. Si algún elemento del producto está dañado, absténgase de instalar el producto y presente una queja. La instalación del producto sobre la base de los elementos dañados supone la aceptación por parte del Comprador de su estado, por lo que no se aceptará la reclamación de elementos dañados.

No se deben exceder los valores de carga máxima especificados. De lo contrario, el mueble puede dañarse o destruirse.

Antes de colgar o fijar el mueble en el muro (a fin de proteger contra el vuelco del mueble), compruebe de antemano la naturaleza y la resistencia de la pared. Seleccione tacos y tornillos adecuados para el tipo de la pared. En caso de duda, consulte a un especialista, debiendo efectuar este montaje una persona competente.

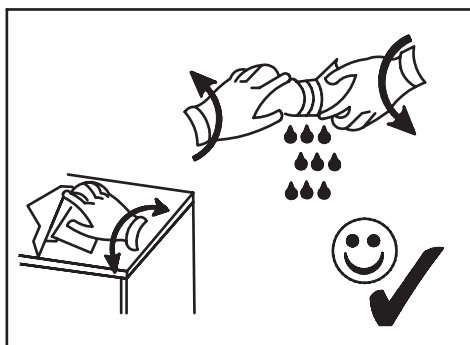
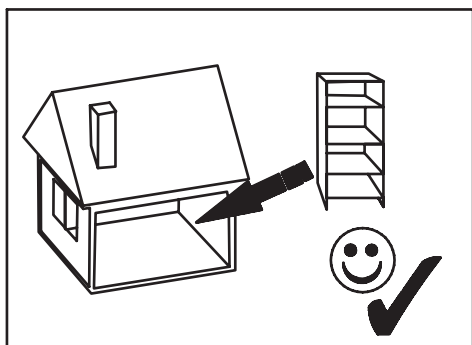
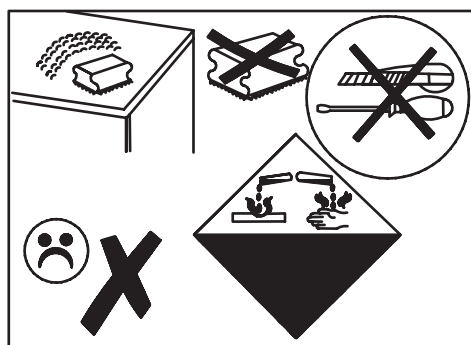
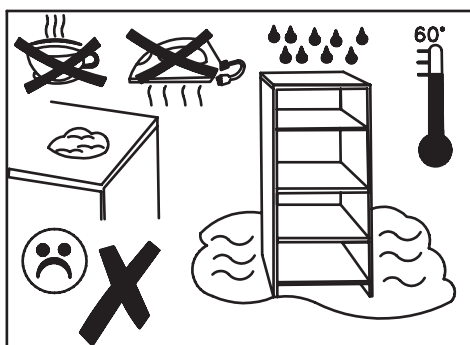
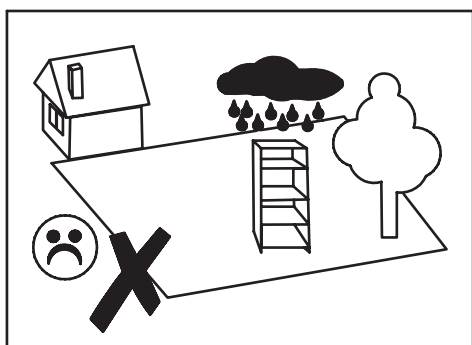

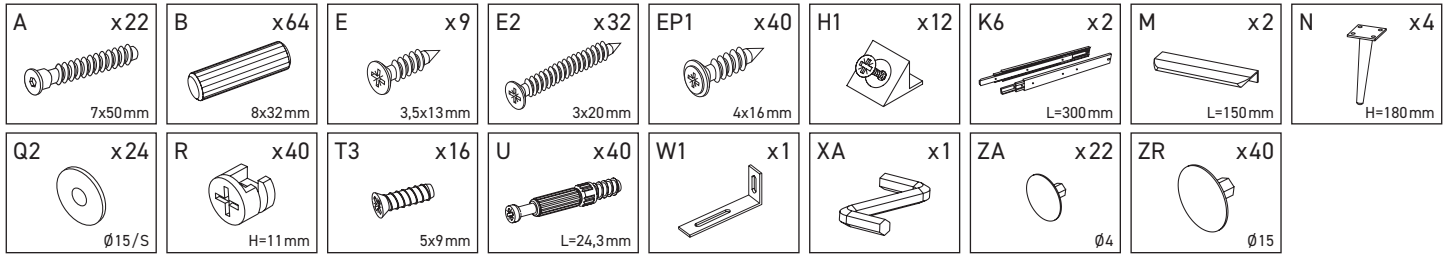

A2-1	882	380	16	x1	2/3
A2-2	882	380	16	x1	2/3
A2-3	1726	314	16	x1	1/3
A2-4	1726	314	16	x1	1/3
A2-5	320	292	16	x4	1/3
A2-6	1726	65	65	x2	1/3
A2-7	846	336	16	x2	2/3
A2-8	846	336	16	x1	2/3
A2-9	846	336	16	x1	2/3
A2-10	846	150	16	x1	1/3
A2-11	746	195	18	x2	1/3
A2-12	678	120	16	x2	1/3
A2-13	300	120	16	x2	1/3
A2-14	300	120	16	x2	1/3
A2-15	382	68	16	x4	1/3
A2-16	708	305	3	x2	1/3
A2-17	862	334	3	x4	1/3
A2-18	862	396	3	x1	1/3

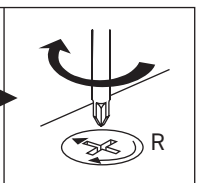
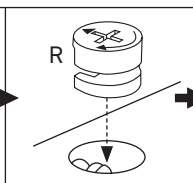
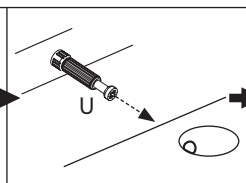
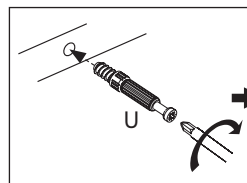
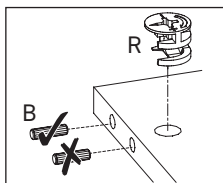
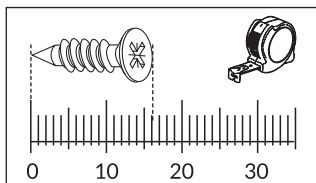
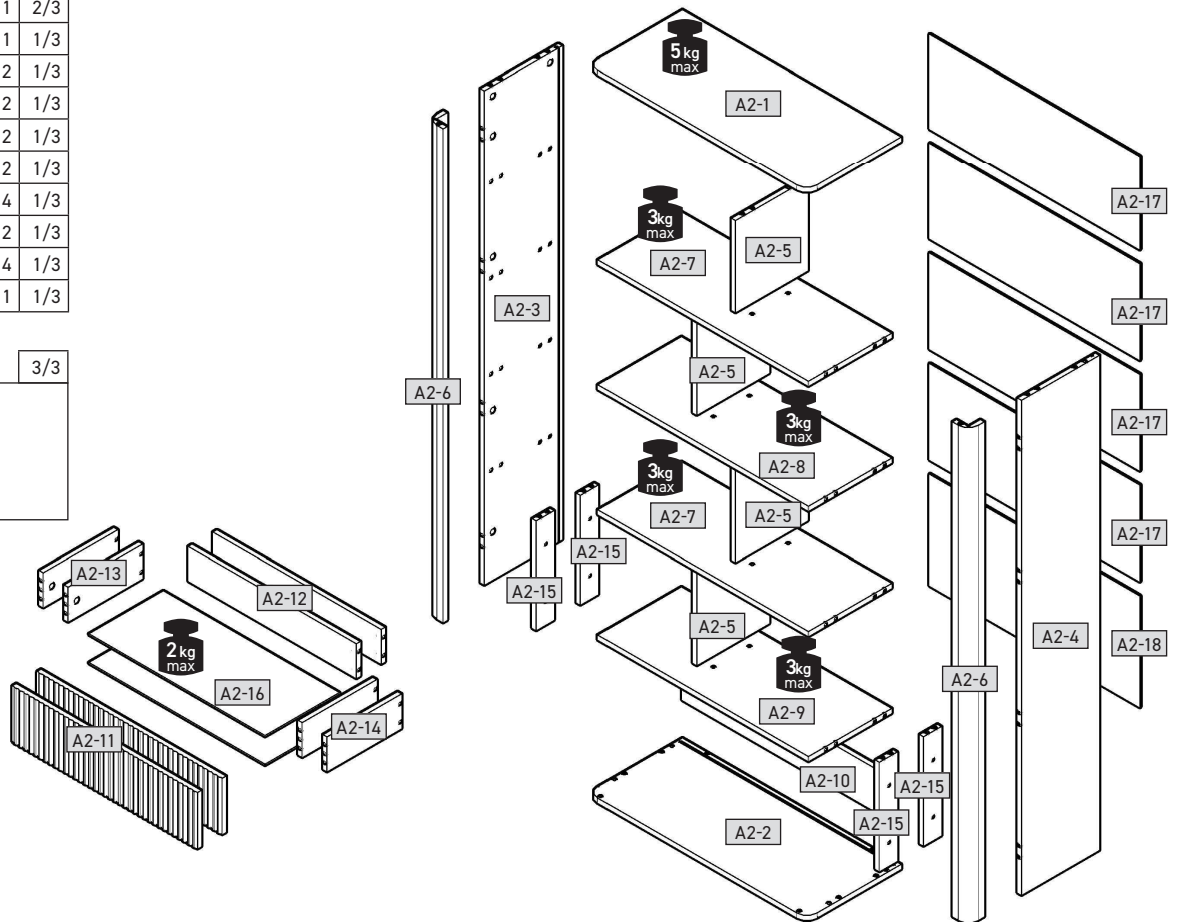
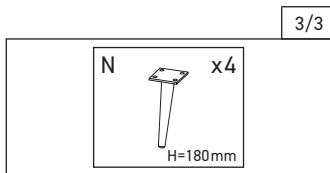



1

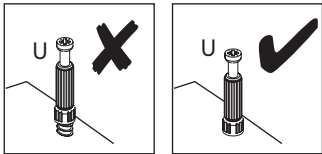
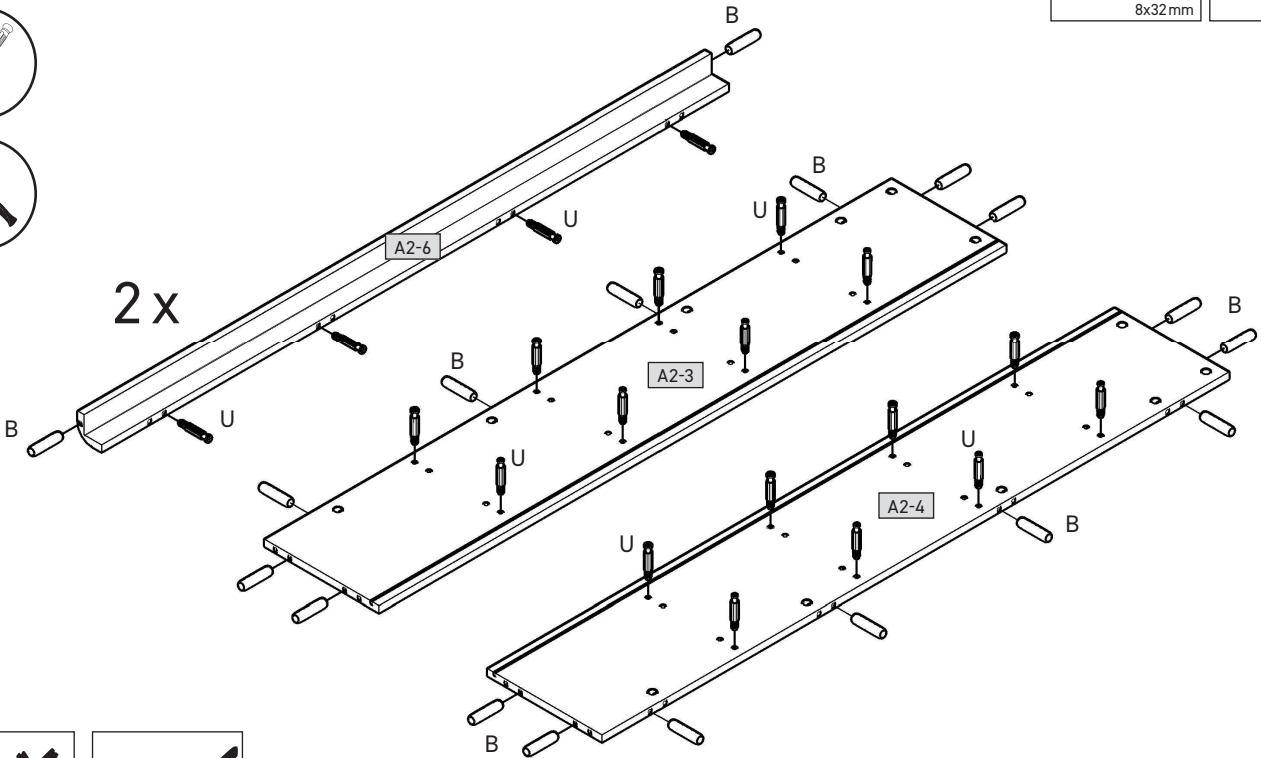
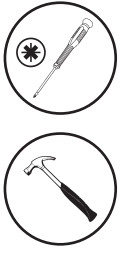
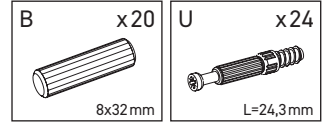

2

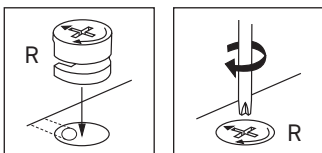
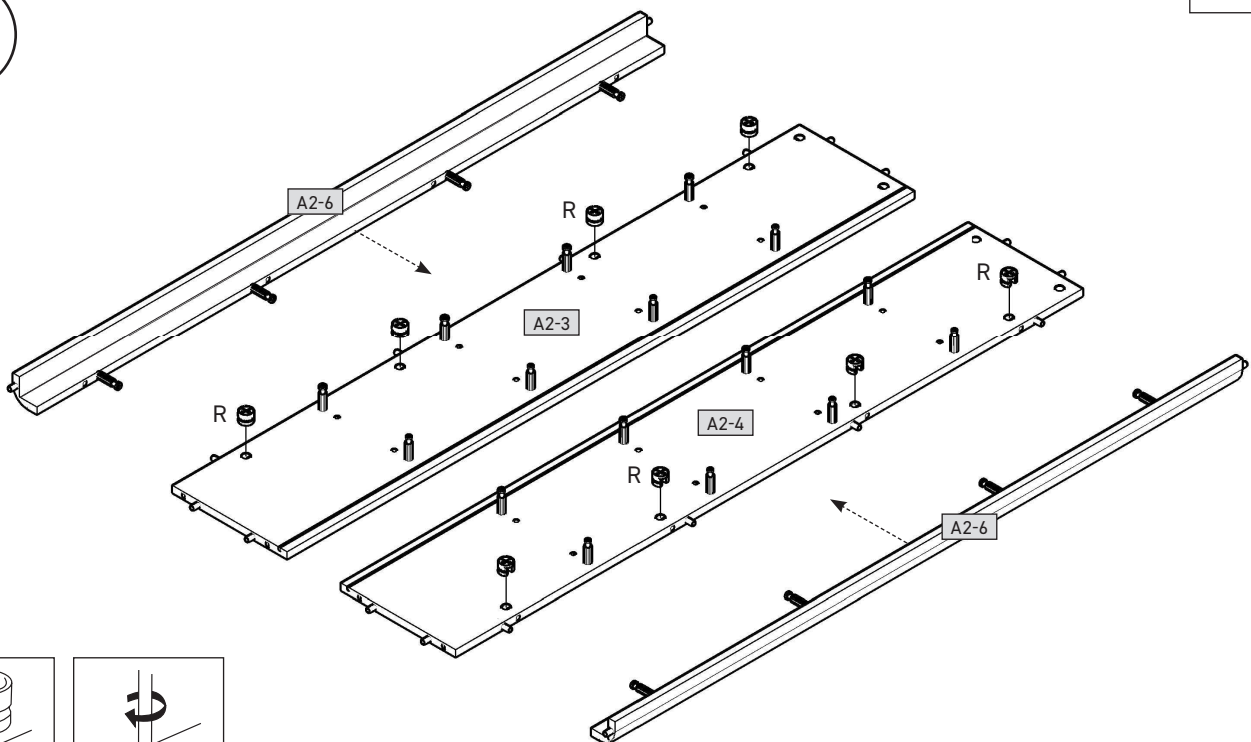
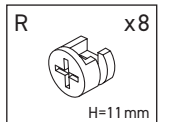



3

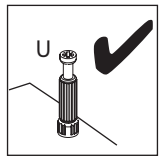
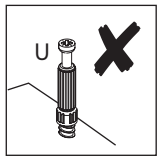
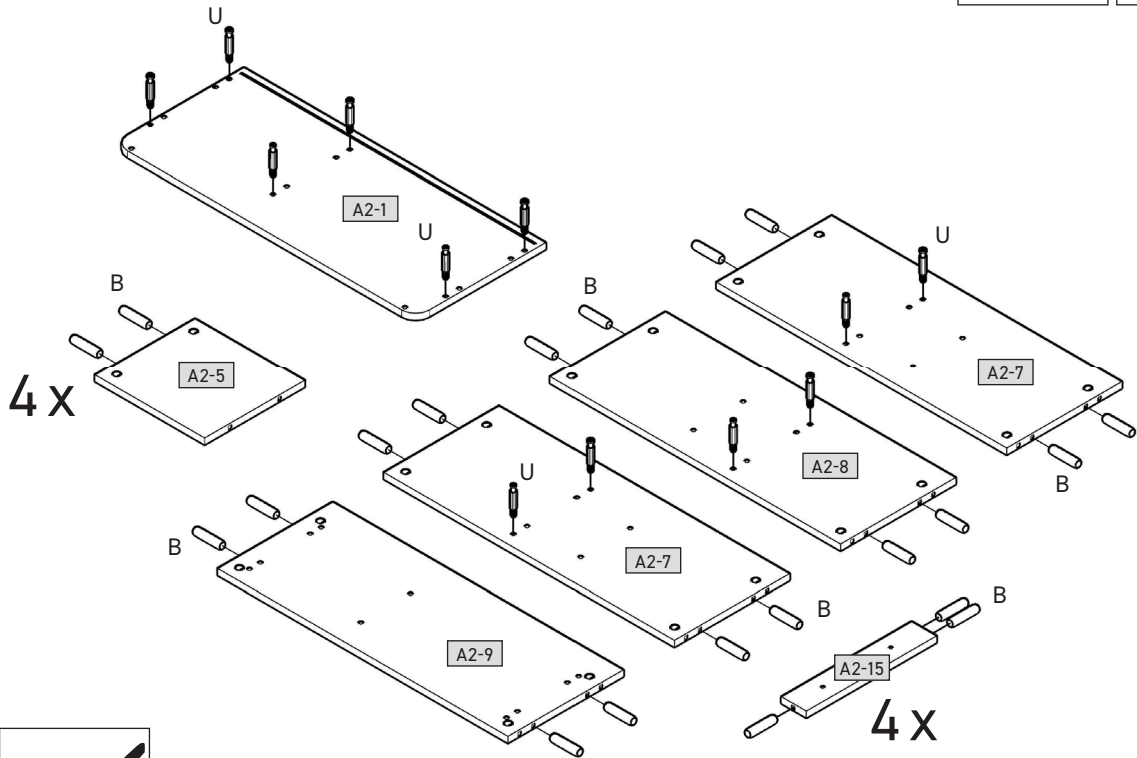
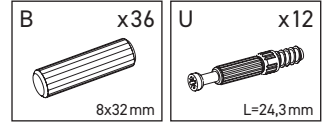

4

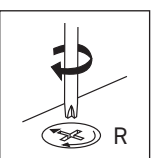
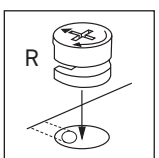
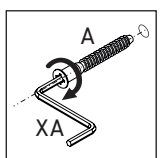
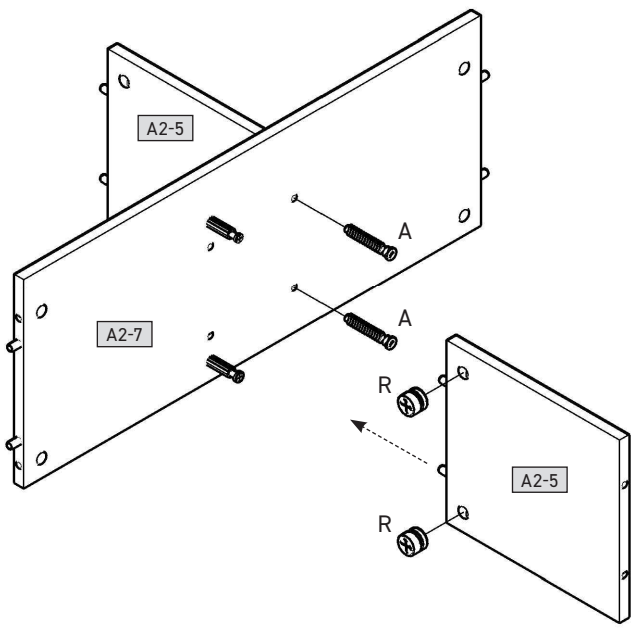
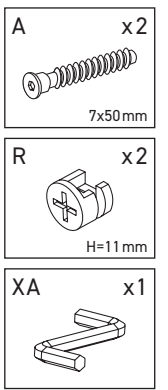



5

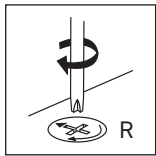
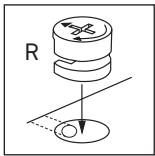
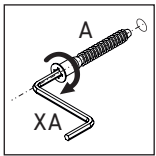
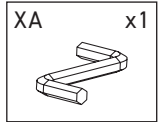
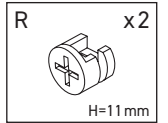
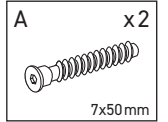
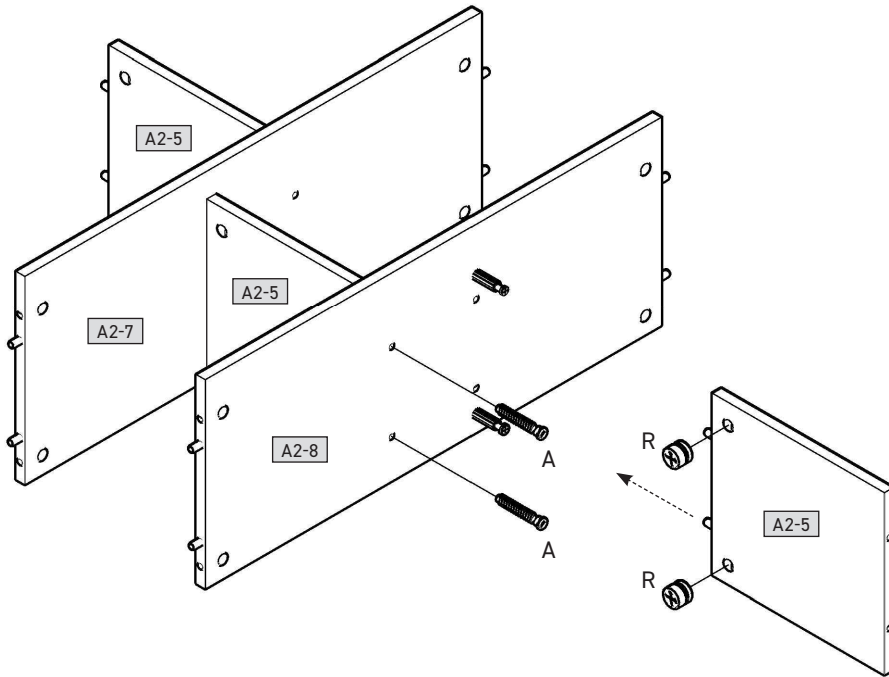

6

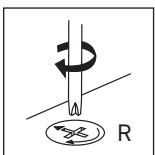
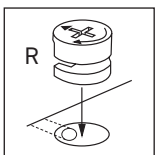
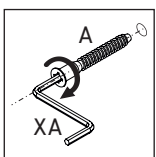
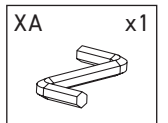
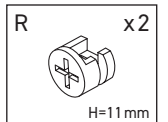
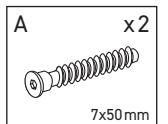
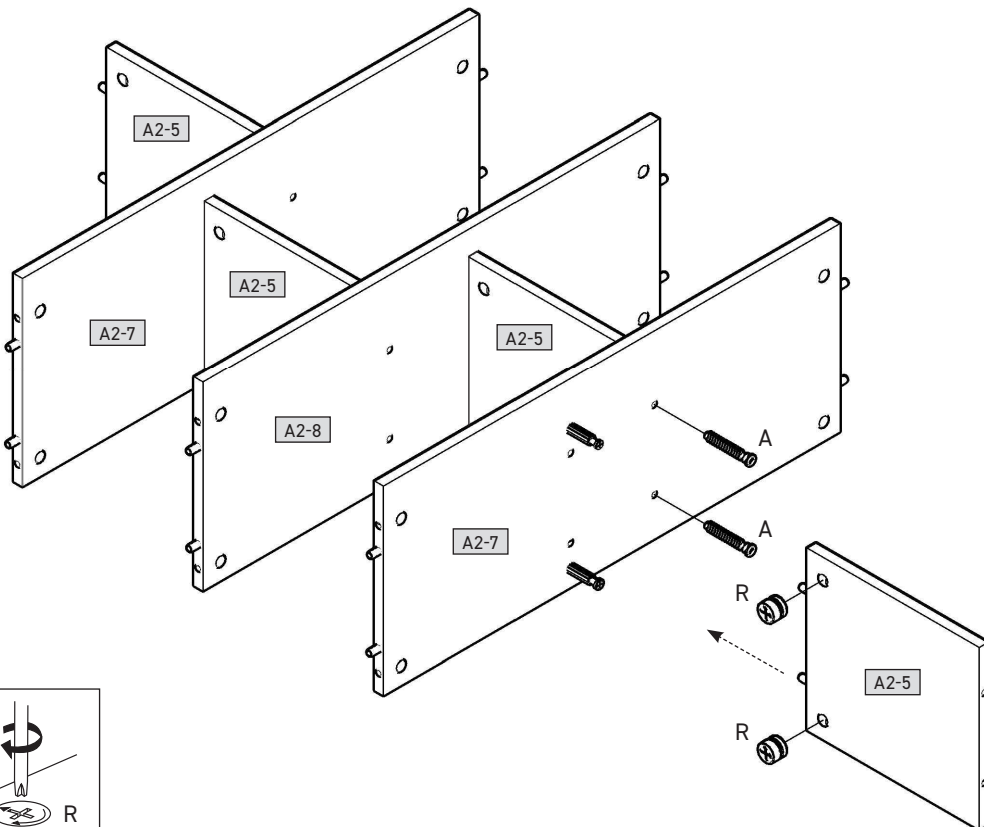



7

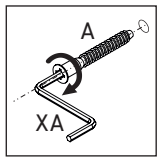
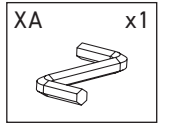
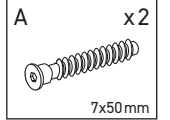
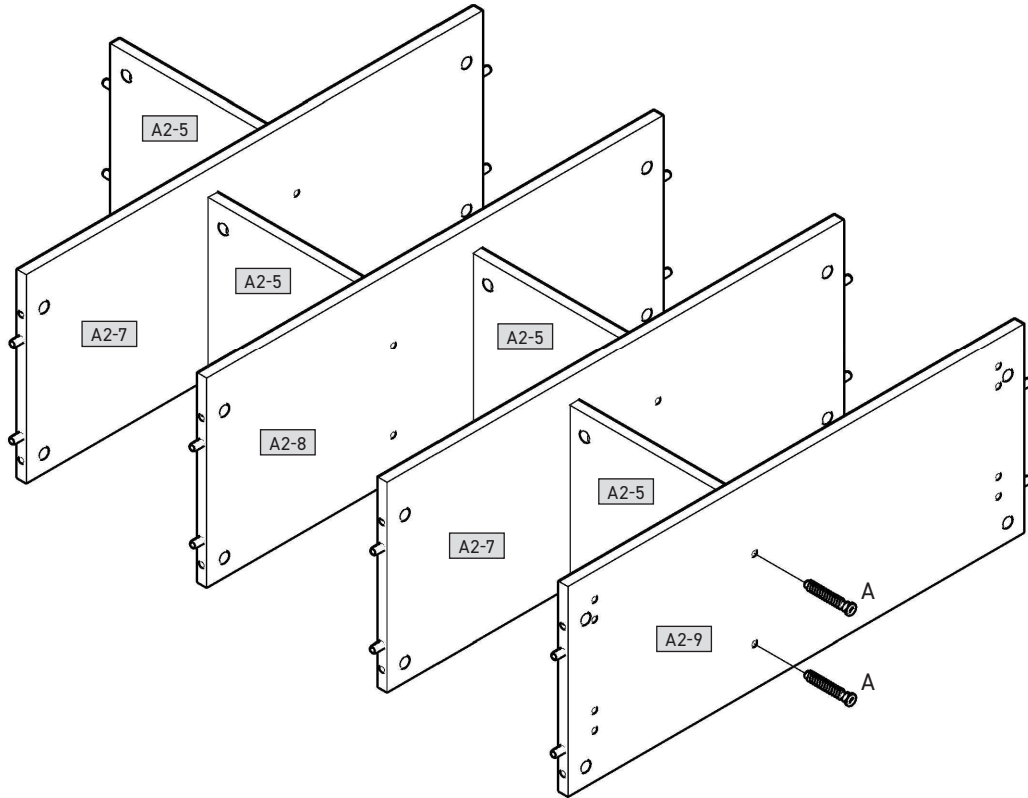

8

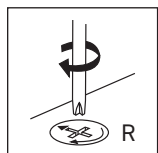
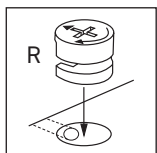
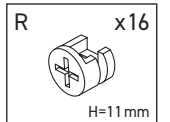
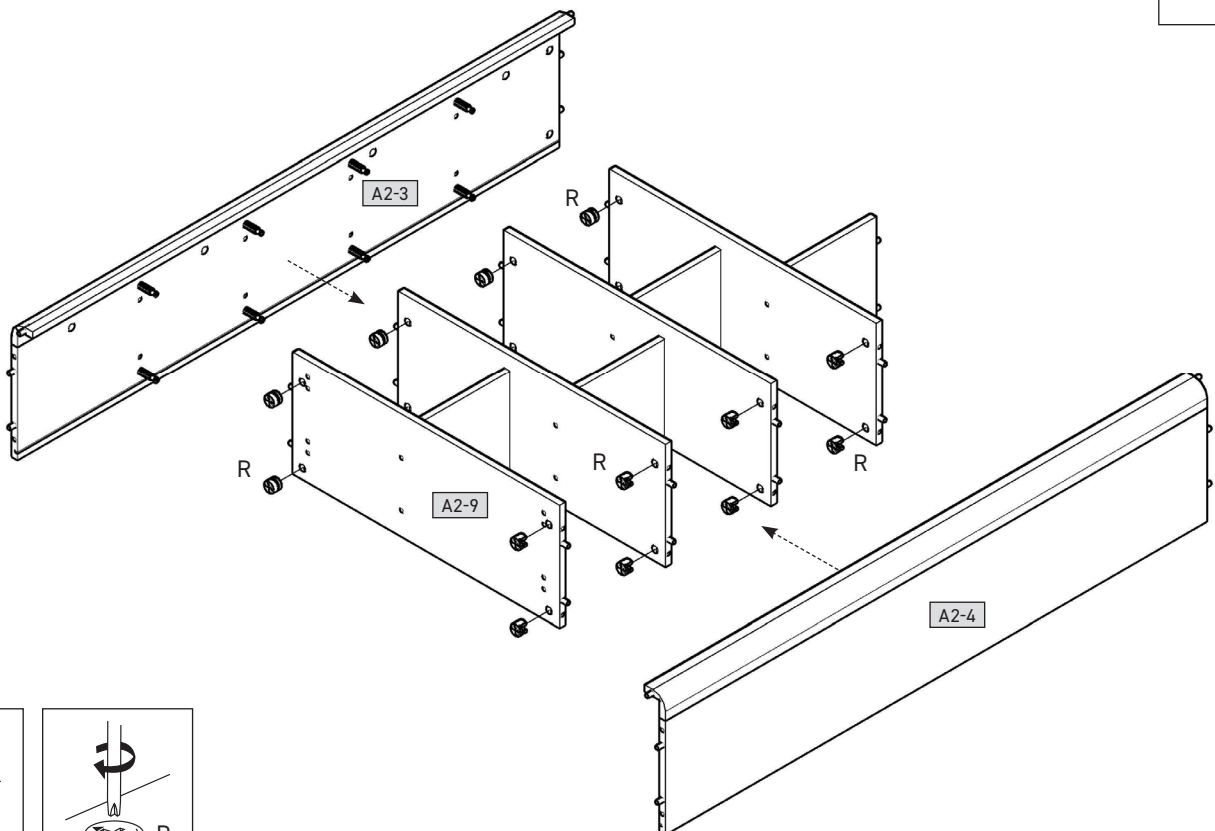



9

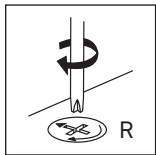
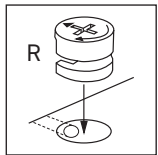
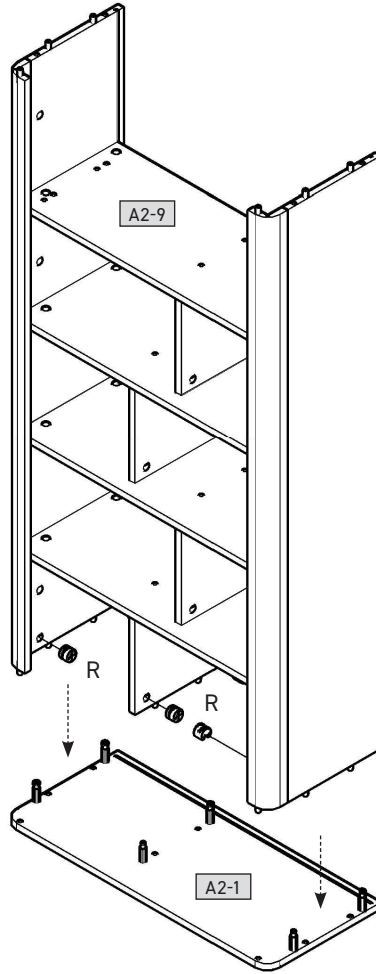
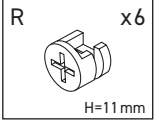

10

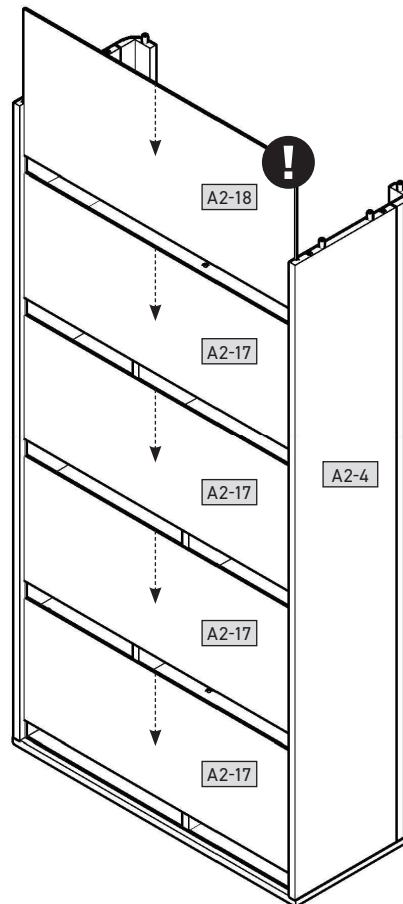



11

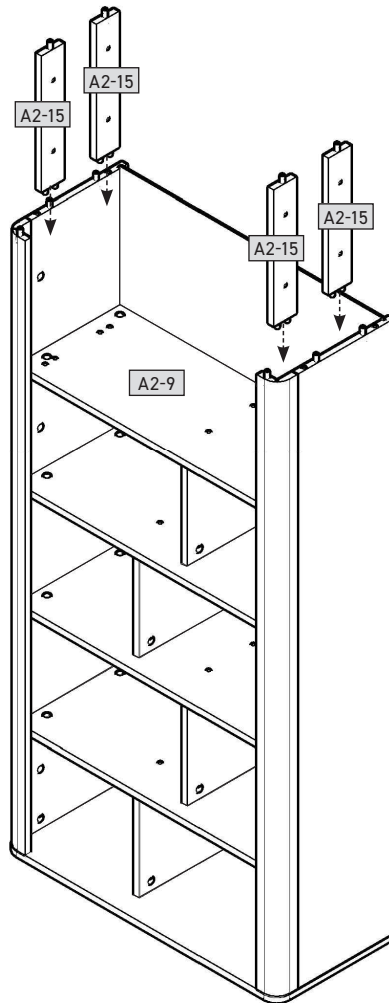

12

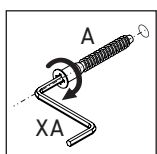
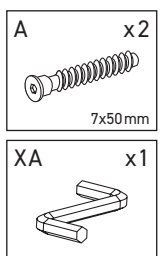
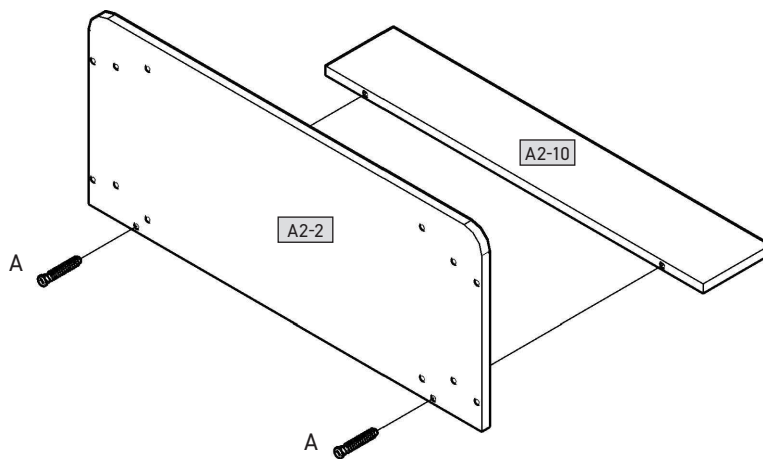

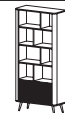

13

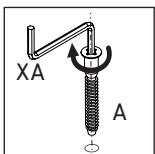
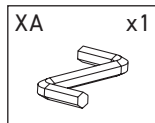
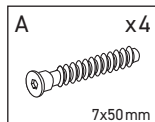
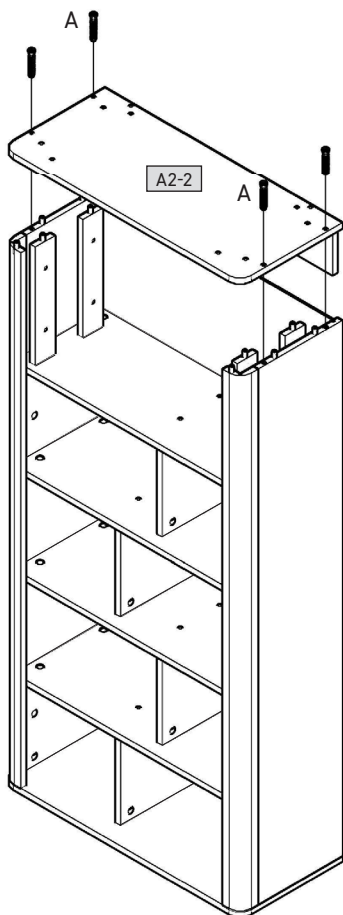

14

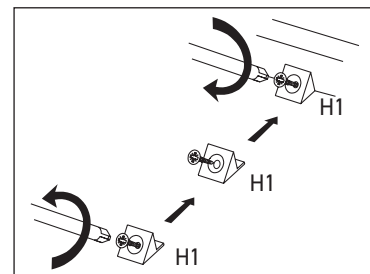
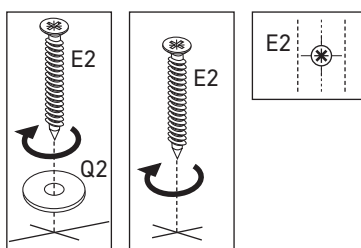
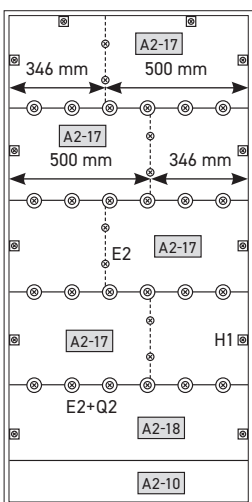
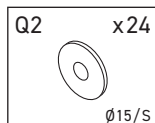
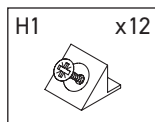
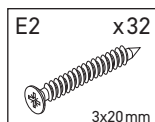
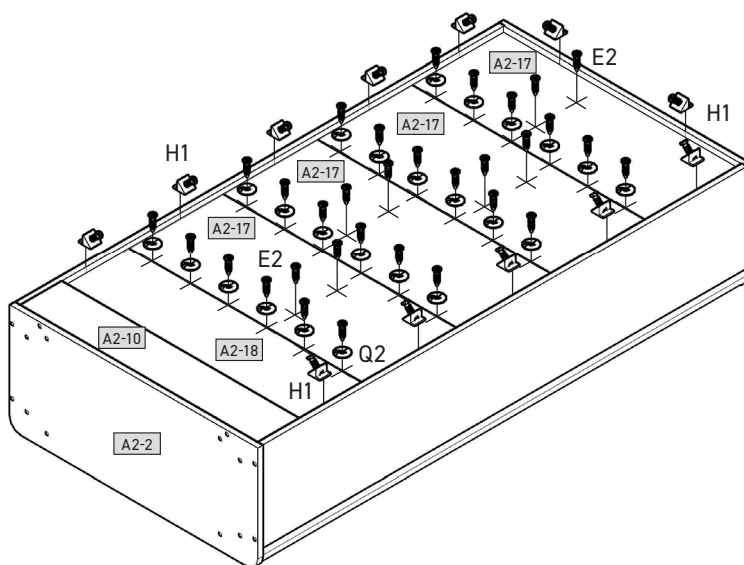
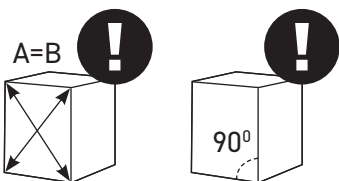

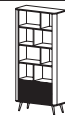

15

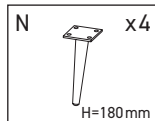
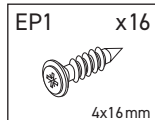
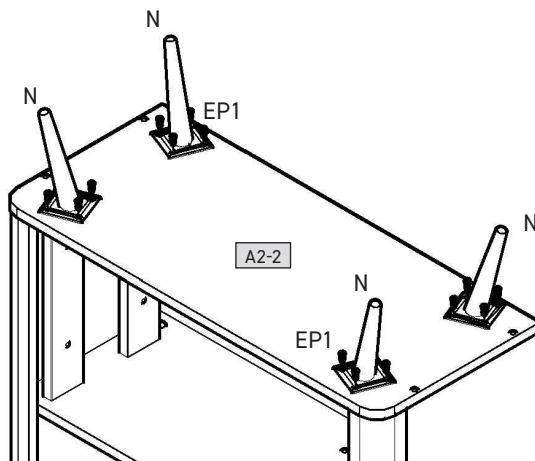
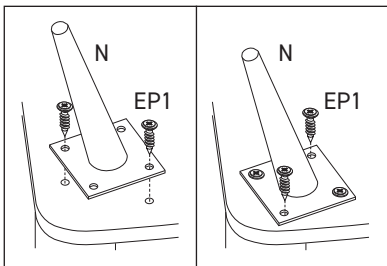

16

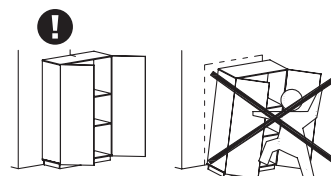
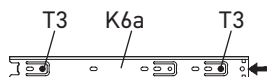
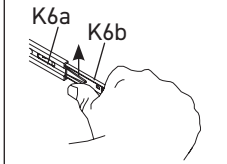
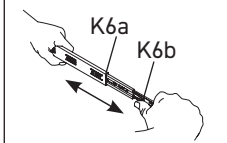
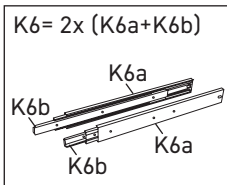
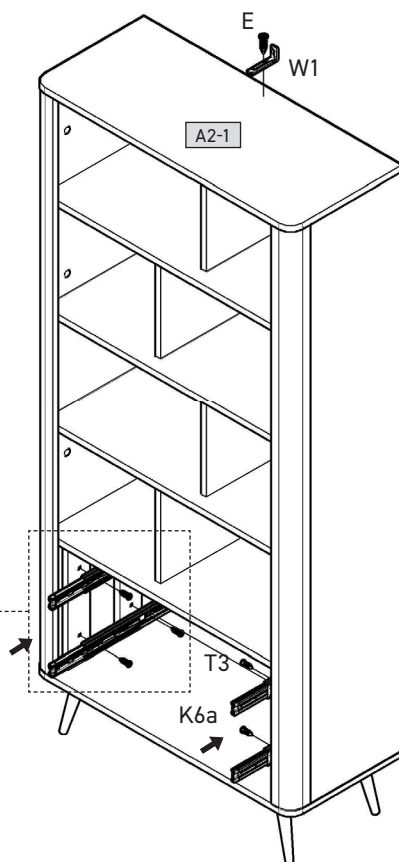
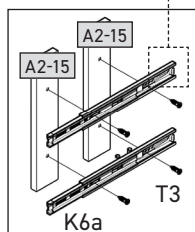
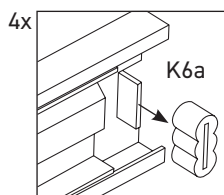
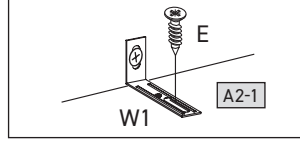
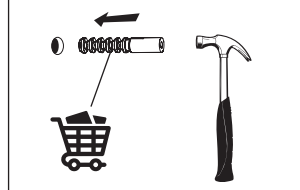
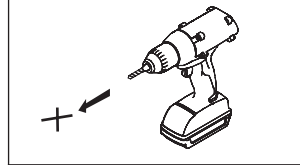
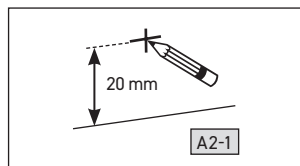
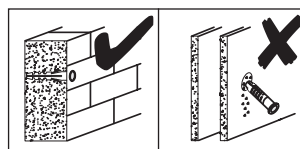
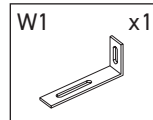
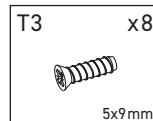
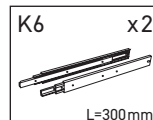
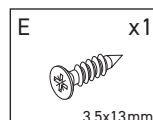
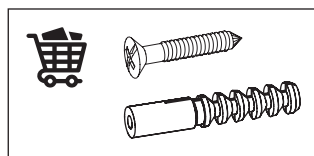
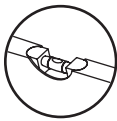



17

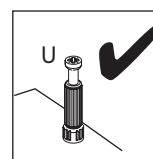
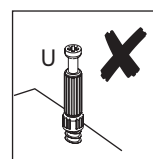
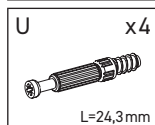
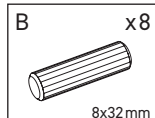
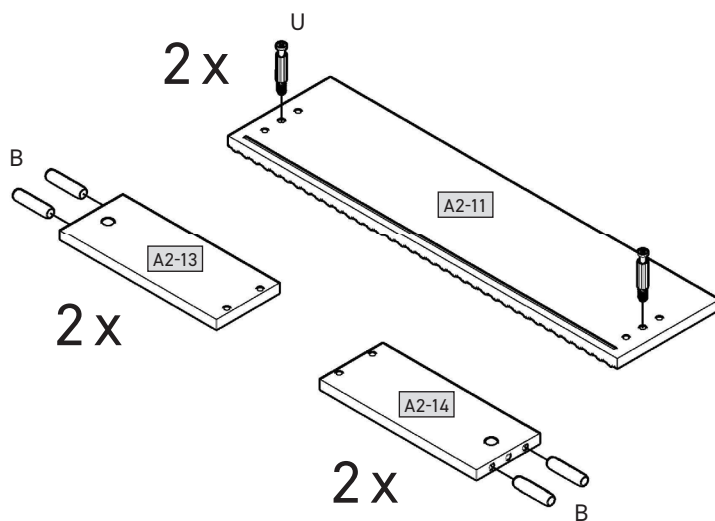

18

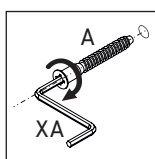
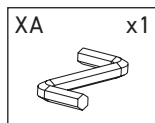
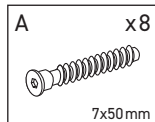
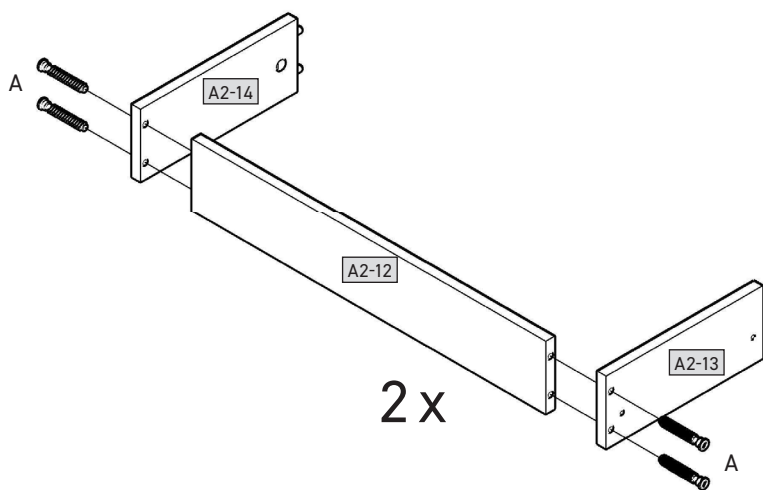

19

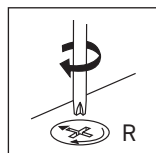
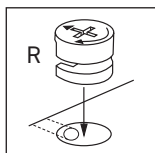
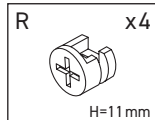
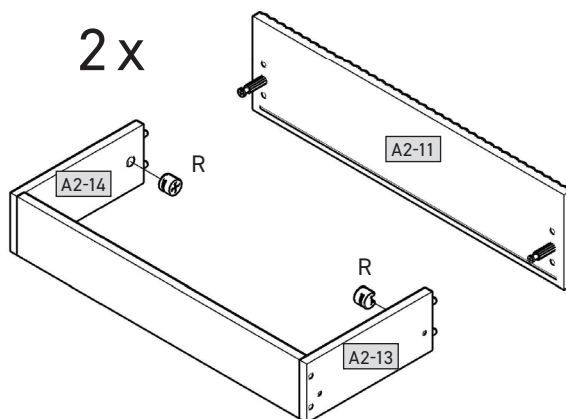



20

2 x

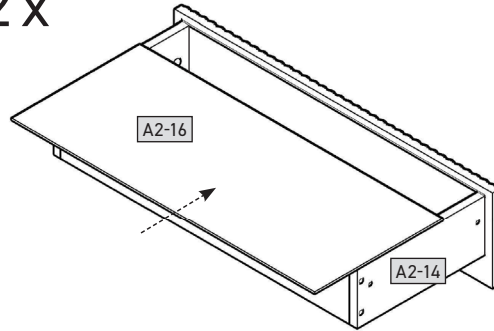

21

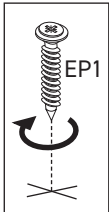

2 x

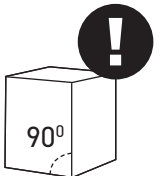
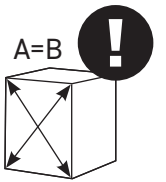
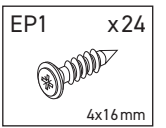
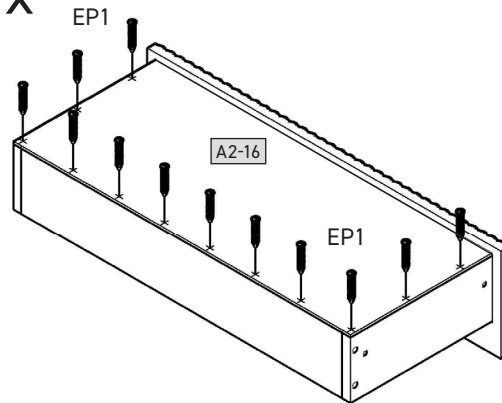

22



2 x

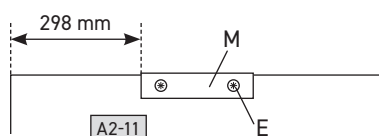
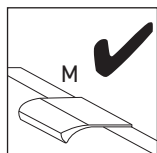
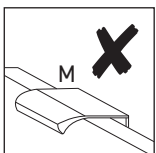
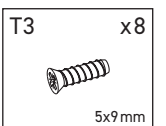
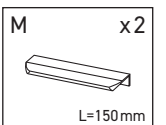
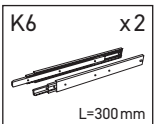
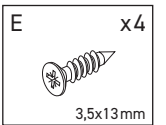
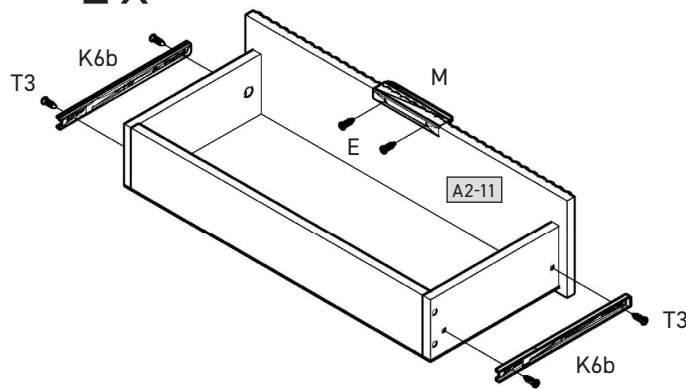

K6= 2x (K6a+K6b)

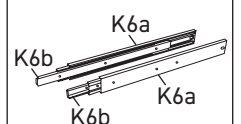



23

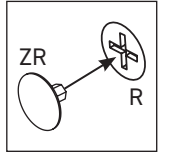
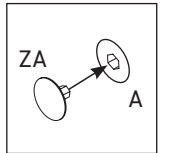
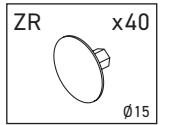
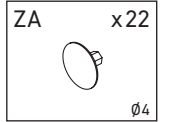
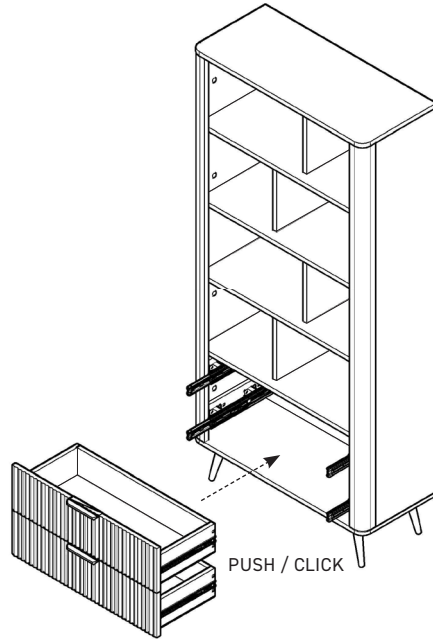

24

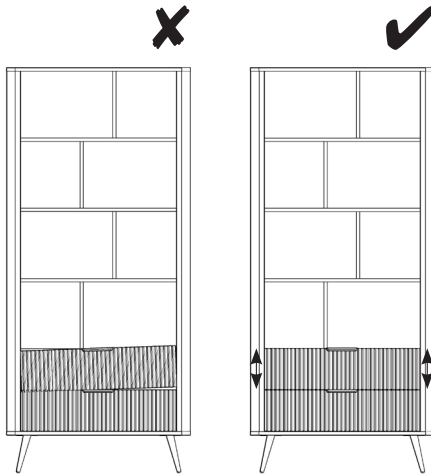

A

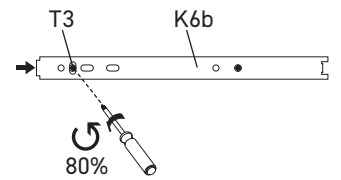
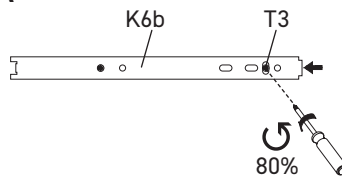

B

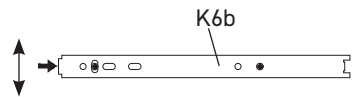
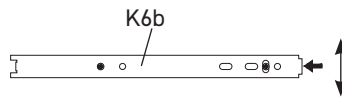

C

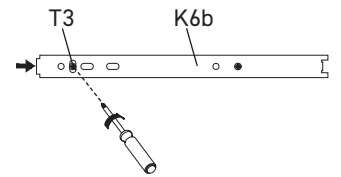
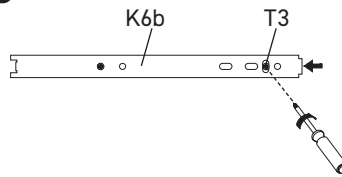

25

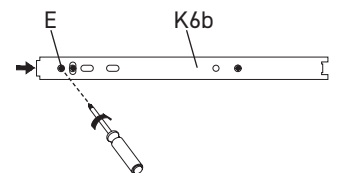
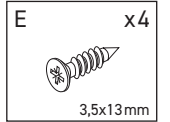
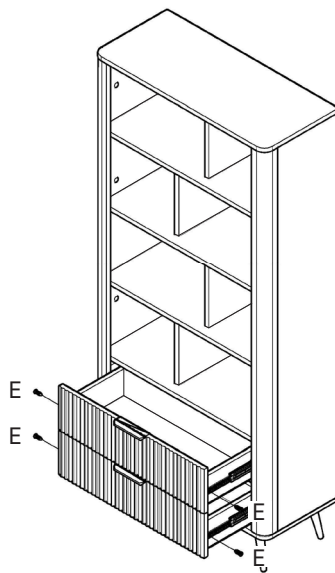
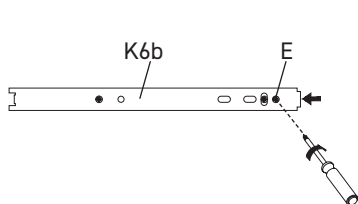

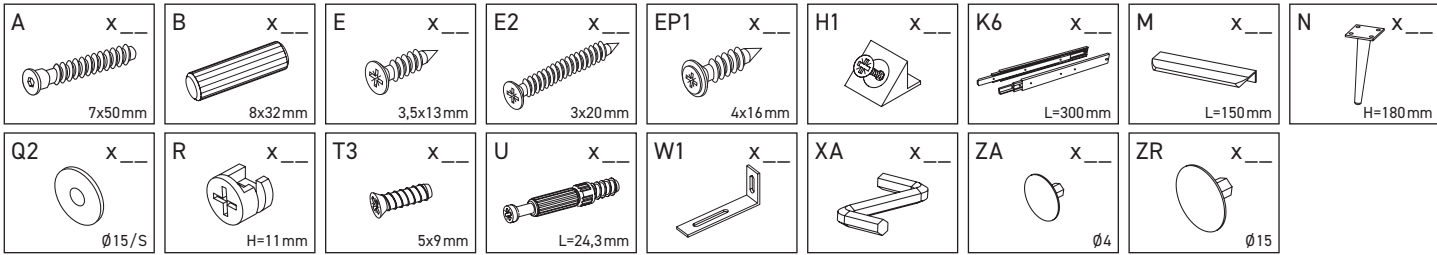

A2-1	882	380	16	x1	2/3
A2-2	882	380	16	x1	2/3
A2-3	1726	314	16	x1	1/3
A2-4	1726	314	16	x1	1/3
A2-5	320	292	16	x4	1/3
A2-6	1726	65	65	x2	1/3
A2-7	846	336	16	x2	2/3
A2-8	846	336	16	x1	2/3
A2-9	846	336	16	x1	2/3
A2-10	846	150	16	x1	1/3
A2-11	746	195	18	x2	1/3
A2-12	678	120	16	x2	1/3
A2-13	300	120	16	x2	1/3
A2-14	300	120	16	x2	1/3
A2-15	382	68	16	x4	1/3
A2-16	708	305	3	x2	1/3
A2-17	862	334	3	x4	1/3
A2-18	862	396	3	x1	1/3

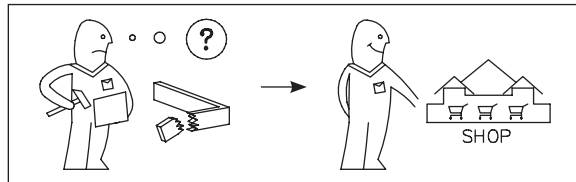
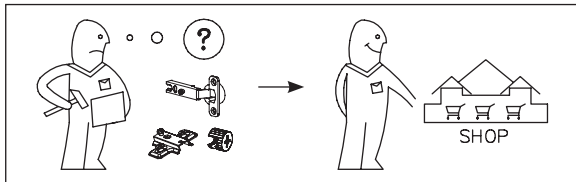
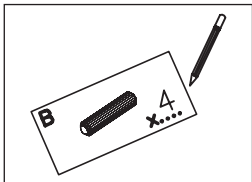
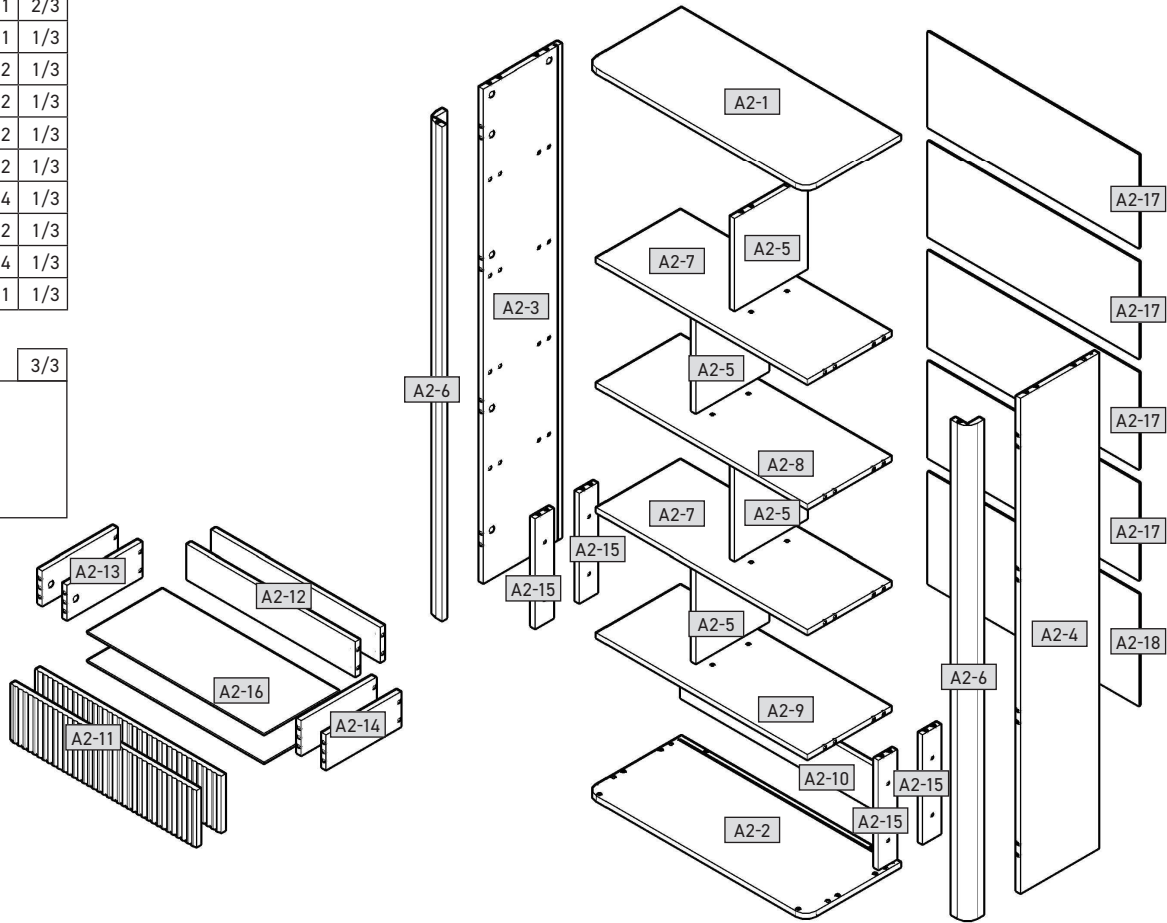
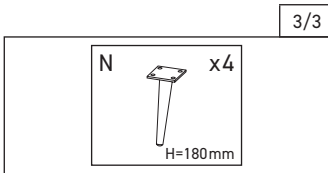

- (DE)** Möbel aus Naturholz und Plattenwerkstoffen
- (PL)** Mebel z drewna naturalnego oraz płył drewnopochodnych
- (NL)** Meubelen van natuurhout en plaatmateriaal
- (GB)** Furniture made of natural wood and panel materials
- (IT)** Mobili in legno naturale e materiali pannellati
- (FR)** Meuble en bois naturel et plaque en dérivé du bois

(DE)

Liebe Kundin,
lieber Kunde,
Hiermit danken wir Ihre Bestellung!
Wir freuen uns, dass Sie sich für ein Möbelstück aus Naturholz entschieden haben.
Die Lieferung erfolgt über DHL.
Bitte beachten Sie, dass die Lieferung nicht auf dem Hausboden, sondern auf einem geeigneten Untergrund (z. B. auf einer Holzpalette) stattfinden muss.
Die Lieferung erfolgt ohne Montageanleitung.
Bitte beachten Sie, dass die Lieferung nicht auf dem Hausboden, sondern auf einem geeigneten Untergrund (z. B. auf einer Holzpalette) stattfinden muss.
Die Lieferung erfolgt ohne Montageanleitung.

Die Lieferung erfolgt ohne Montageanleitung.
Bitte beachten Sie, dass die Lieferung nicht auf dem Hausboden, sondern auf einem geeigneten Untergrund (z. B. auf einer Holzpalette) stattfinden muss.
Die Lieferung erfolgt ohne Montageanleitung.

Bitte beachten Sie, dass die Lieferung nicht auf dem Hausboden, sondern auf einem geeigneten Untergrund (z. B. auf einer Holzpalette) stattfinden muss.
Die Lieferung erfolgt ohne Montageanleitung.

Bitte beachten Sie, dass die Lieferung nicht auf dem Hausboden, sondern auf einem geeigneten Untergrund (z. B. auf einer Holzpalette) stattfinden muss.
Die Lieferung erfolgt ohne Montageanleitung.

Bitte beachten Sie, dass die Lieferung nicht auf dem Hausboden, sondern auf einem geeigneten Untergrund (z. B. auf einer Holzpalette) stattfinden muss.
Die Lieferung erfolgt ohne Montageanleitung.

Bitte beachten Sie, dass die Lieferung nicht auf dem Hausboden, sondern auf einem geeigneten Untergrund (z. B. auf einer Holzpalette) stattfinden muss.
Die Lieferung erfolgt ohne Montageanleitung.

Bitte beachten Sie, dass die Lieferung nicht auf dem Hausboden, sondern auf einem geeigneten Untergrund (z. B. auf einer Holzpalette) stattfinden muss.
Die Lieferung erfolgt ohne Montageanleitung.

Bitte beachten Sie, dass die Lieferung nicht auf dem Hausboden, sondern auf einem geeigneten Untergrund (z. B. auf einer Holzpalette) stattfinden muss.
Die Lieferung erfolgt ohne Montageanleitung.

Bitte beachten Sie, dass die Lieferung nicht auf dem Hausboden, sondern auf einem geeigneten Untergrund (z. B. auf einer Holzpalette) stattfinden muss.
Die Lieferung erfolgt ohne Montageanleitung.

Bitte beachten Sie, dass die Lieferung nicht auf dem Hausboden, sondern auf einem geeigneten Untergrund (z. B. auf einer Holzpalette) stattfinden muss.
Die Lieferung erfolgt ohne Montageanleitung.

Bitte beachten Sie, dass die Lieferung nicht auf dem Hausboden, sondern auf einem geeigneten Untergrund (z. B. auf einer Holzpalette) stattfinden muss.
Die Lieferung erfolgt ohne Montageanleitung.

Ihre Produktentwicklung

(TR)

Doğal ağşap ve kereste malzemelerden Üretimişi mobilyalar

(RU)

Мебель из натурального дерева и древесных панелей.

(RO)

Mobiliă din lemn natural și materiale fibrolemnoase

(CZ)

Nábytek z přírodního dřeva a deskových materiálů

(SK)

Nábytok z prírodného dreva a drevovláknitých deskových materiálov

(HU)

Bűtor természetesen faanyagból és bútortápolából

(NL)

Beste klant,

Hier met dank voor uw bestelling!
We zijn blij dat u heeft gekocht bij ons.
De levering wordt verzorgd door DHL.
De levering vindt plaats op de afgeleverde locatie (bijv. op een pallet).
De levering vindt plaats op de afgeleverde locatie (bijv. op een pallet).

De levering vindt plaats op de afgeleverde locatie (bijv. op een pallet).

De levering vindt plaats op de afgeleverde locatie (bijv. op een pallet).

De levering vindt plaats op de afgeleverde locatie (bijv. op een pallet).

De levering vindt plaats op de afgeleverde locatie (bijv. op een pallet).

De levering vindt plaats op de afgeleverde locatie (bijv. op een pallet).

De levering vindt plaats op de afgeleverde locatie (bijv. op een pallet).

De productontwikkelingsafdeling

(GB)

Dear customer,

Thank you for your order!
We are pleased that you have purchased a piece of furniture from us.
Delivery is organized by DHL.
Delivery takes place at the designated location (e.g. on a pallet).

Delivery takes place at the designated location (e.g. on a pallet).

Delivery takes place at the designated location (e.g. on a pallet).

Delivery takes place at the designated location (e.g. on a pallet).

Delivery takes place at the designated location (e.g. on a pallet).

Delivery takes place at the designated location (e.g. on a pallet).

Delivery takes place at the designated location (e.g. on a pallet).

Delivery takes place at the designated location (e.g. on a pallet).

Delivery takes place at the designated location (e.g. on a pallet).

Delivery takes place at the designated location (e.g. on a pallet).

Delivery takes place at the designated location (e.g. on a pallet).

Delivery takes place at the designated location (e.g. on a pallet).

Your product development team

(IT)

Gentili clienti,

Sentiti ringraziamenti per il vostro ordine!
A prescindere che abbiate scelto un mobile realizzato in legno naturale, un fronte lucido o un fronte di materiale plastico opaco – ogni esemplare ha sue particolarità. Anche le caratteristiche e la struttura del legno, quali ad esempio rami minori nei mobili di legno naturale, sono parte del fascino individuale di ogni singolo mobile.

Dato che i mobili in legno naturale sono esposti al continuo variare del clima e dell'umidità, è probabile che in superficie insorgano mutamenti quali crepe capillari o cambiamenti di colore. Generalmente con passar del tempo diminuisce la chiarezza e aumenta la saturazione del colore – il legno si scurisce. I citati mutamenti sono un normale processo dei materiali naturali, quali appunto il legno.

Il presente libretto intende darvi alcuni suggerimenti sulla cura del vostro mobile, affinché vi procuri lunghe soddisfazioni.

Sostanzialmente vale:

- Non poggiare oggetti roventi sui mobili.
- Non poggiare candele a diretto contatto dei mobili.
- Asciugare subito i liquidi sversati.
- Ad intervalli periodici controllare se vitì e cerriere sono salde.
- Il caratteristico odore fragrante è sempre una prova di qualità dei mobili in legno naturale.
- Le macchie chiare sui rami si formano per via della naturale fuoriuscita di resina, e sono levigabili con un panno asciutto che non lascia peli.
- Anche trattandosi di altri materiali lignei, di vernice, pelle o bottoliti, all'inizio è inevitabile un leggero odore caratteristico. Dopo qualche tempo però, questi odori svaniscono o, al più, molesto, che non lascia peli, o un minor tempo cambiando più spesso aria all'inizio e/o passando sui mobili con un panno umido d'acqua con qualche goccia d'aceto.
- Conservare bene le presenti istruzioni.

Istruzioni sulla cura dei mobili in materiali pannellati
Per la cura dei mobili in materiali pannellati si consiglia di usare un panno morbido, che non lascia peli, o un panno di pelle. Passare il panno leggermente umido sulle superfici.

Sostanzialmente vale: In nessun caso utilizzare i seguenti detergenti e prodotti per la pulizia:

- panni in microfibra o spugna tampono.** Questi prodotti contengono spesso fini particelle abrasive, che possono provocare sgraffiature sui mobili;
- forti sostanze chimiche nonché detersivanti o solventi abrasivi.** Anche questi prodotti possono aggredire le superfici;
- polvere abrasiva, paglietta d'acciaio o spugna abrasiva.** Rovinerebbero la superficie in modo tale che non sarebbe più possibile riparare;
- aspirapolvere.** Bocchette e spazzole possono sgraffiare le superfici;
- pulitrice a vapore.** Per via dell'elevata pressione e calore con cui il vapore colpisce le superfici, esse rischiano di deteriorarsi o addirittura staccarsi dalla sottostruttura.

Area Sviluppo prodotti

(FR)

Chère client,
Cher client,
Nous vous remercions de votre commande !
Peu importe que vous ayez acheté un meuble fabriqué en bois naturel, un face haute brillante ou une face en plastique mat – chaque meuble a ses propres spécificités. Même les propriétés et la structure du bois, comme par exemple les petits nœuds sur des meubles en bois naturel, font partie de l’aspect de chaque meuble.

Comme les variations permanentes du climat et de l’humidité, il se peut que quelques modifications surviennent sur la surface, comme par exemple de fines fissures ou des décorations. En règle générale, au cours du temps, la clarté du lmeuble diminue et le bois devient foncé.

Les modifications susnommées sont un processus normal des matières naturelles et des bois.
Ce petit livret vous donne quelques astuces sur l’entretien de votre meuble pour que vous puissiez en profiter longtemps.

En règle générale :
• Ne pas poser d’objets chauds sur le meuble.
• Ne pas poser de bougies directement sur le meuble.
• Essayer immédiatement les liquides renversés.

• A intervalles réguliers, compter que les vis et les ferrures sont bien en place.
• Locuer aromatique typique du bois est toujours une preuve de qualité des meubles en bois naturel.
Les endroits clairs sur les nœuds se produisent par une sécrétion naturelle de résine qui s’élimine avec un chiffon sec non pelucheux.

Les autres matériaux, comme le bois, la pierre ou la peau, peuvent s’abîmer et dégrader inévitablement une légère odeur. Ces odeurs disparaissent d’elles-mêmes avec le temps. Si vous souhaitez qu’elles disparaissent plus vite, au début, aérez plus souvent et essayez les meubles avec un chiffon légèrement imbibé d’eau mélangée avec un peu de vinaigre.

Conservez bien cette notice.

Consignes de soin pour les meubles avec des plaques en dérivé du bois
Pour l’entretien de votre meuble en bois naturel, utilisez un chiffon doux, non pelucheux à une partie de coton ou de lin. Essayez la méthode suivante :

En règle générale : Veuillez n’ utiliser

Consignes de soin pour les meubles avec des plaques en dérivé du bois
Pour l’entretien de votre meuble en bois naturel, utilisez un chiffon doux, non pelucheux à une partie de coton ou de lin. Essayez la méthode suivante :

En règle générale : Veuillez n’ utiliser

Consignes de soin pour les meubles avec des plaques en dérivé du bois
Pour l’entretien de votre meuble en bois naturel, utilisez un chiffon doux, non pelucheux à une partie de coton ou de lin. Essayez la méthode suivante :

Verre svecie de développement de produits

